

Imported by Amart Furniture Pty Ltd, Qld, Brisbane Australia.
For any assistance with assembly or for missing parts please phone
Amart Furniture, Customer Service Free call 1800 351 084

PRE-ASSEMBLY PREPARATION

Before you start:

1. Choose a clean, level, spacious assembly area. Avoid hard surfaces that may damage the product
2. Take care when lifting. Product should be assembled as near as possible to the point of use
3. Ensure that you have all required contents for complete assembly
4. Always read the assembly instructions carefully before beginning assembly.
5. Keep all hardware parts and packaging out of reach of small children.
6. Do not over tighten the screws and bolts as this may damage the threads



ALLOW **5** MINUTES







1 PEOPLE REQUIRED

WARNING

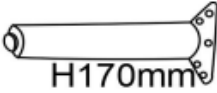
Do Not allow children to play on this mechanised furniture or operate the mechanism. Leg rest folds down on closing so that a child could possibly be injured. Always leave in an upright and closed position. Keep hands and feet clear of mechanism. Only the occupant should operate it.

Parts List

A		Seat	1pc
B		Leg	4pcs
C	 M8×30mm	Bolt	4pcs
D	 M5×30mm	Screw	16pcs
E		Allen key	1pc

STEP 1: Turn over onto blanket or carpet to ensure no damage to item. Place legs(B) into positions as shown , Using the Allen key(E),insert bolt(C) into the hole turning clockwise until tightened by hand. Then insert Screw(D) into the wooden frame using a screwdriver (not provide).

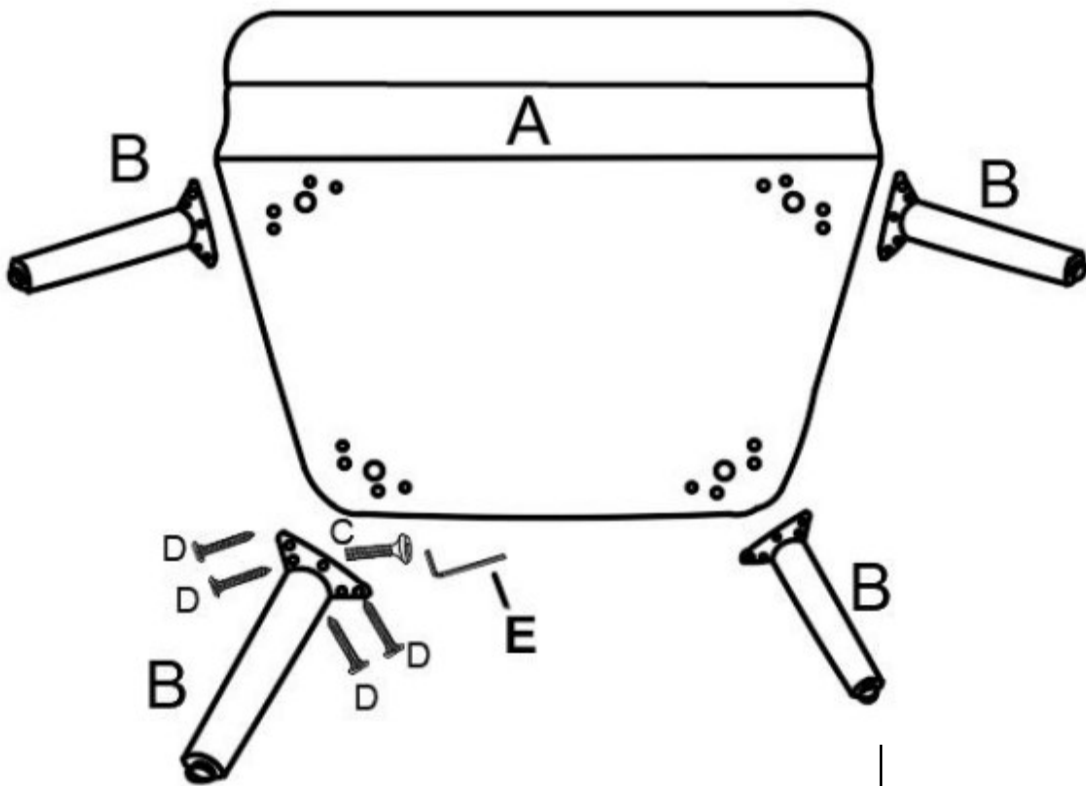

NOTE:

The leveler can be adjusted.



STEP2: Assembly complete

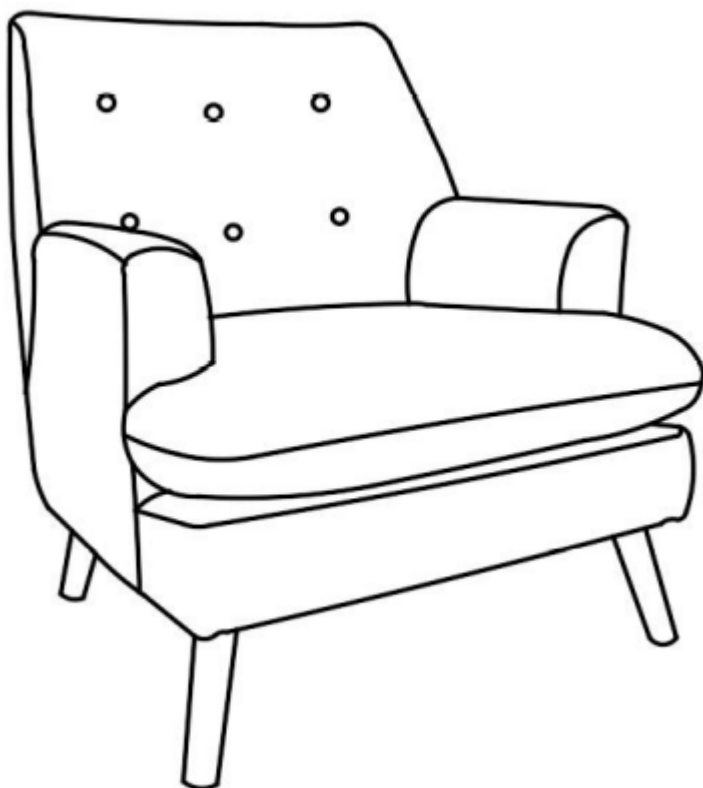

REGULAR CARE:

- * Protect from direct sunlight
- * Vacuum regularly using low suction
- * Rotate reversible cushions regularly

CLEANING:

- * Do not remove cushion covers for separate cleaning even though they may have zippers
- * Do not wash . Do not dry clean. Do not shampoo clean
- * Clean with hot water extraction machine. Professional cleaning recommended
- * Do not use dishwashing liquid or laundry detergent
- * Use only upholstery detergents
- * Do not wet filling
- * Dry in shade away from direct heat and sunlight
- * Allow to dry thoroughly before re-use

SPOT CLEANING

- * Do not rub
- * Do not spot clean with any solvent
- * Treat spills and stains as soon as possible
- * Gently scrape off any soil or mop and liquid from the surface of the fabric
- * Apply proprietary cleaning agents strictly according to instructions to remove the residue or the spill
- * Do not saturate the fabric or interior with water or other cleaning liquids

WARNING:

Apply only water-based soil resist (fabric protection) treatments. Do not use aerosol products

*** PILLING IS NOT A FABRIC DEFECT OR FAULT AND IS NOT COVERED BY WARRANTY**

*** PILLING IS A NORMAL OCCURRENCE IN WOVEN FABRICS AND DOES NOT AFFECT THE DURABILITY OR FUNCTIONALITY OF THE FABRIC. IT IS EASILY REMOVED BY USE OF A BATTERY OPERATED DE-PILLING MACHINE AS THE NEED ARISES**

Do not: Use this product as a step stool or ladder
Failure to follow this warning could result in injury